

# Specification

## SSC-SZG05A0A

## SZG05A0A

### Description

The Z-Power series is designed for high current operation and high flux output applications.

It incorporates state of the art SMD design and low thermal resistant material.

The Z Power LED is ideal light sources for general illumination applications, custom designed solutions, large backlights and high performance torches.

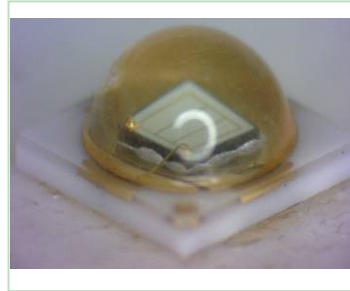

## SZG05A0A

### Features

- Super high Flux output and high Luminance
- Designed for high current operation
- SMT solderable
- Lead Free product
- RoHS compliant

### Applications

- General Torch
- Architectural lighting
- Projector light source
- Traffic signals
- Task lighting
- Decorative / Pathway lighting
- Remote / Solar powered lighting
- Automotive interior / exterior lighting
- Automotive signal / forward lighting

\* The appearance and specifications of the product can be changed for improvement without notice.

# [ Contents ]

- 1. Full code of Z5 Series**
- 2. Outline dimensions**
- 3. Characteristics of SZG05A0A (Green)**
- 4. Characteristic diagrams**
- 5. Bin Code Description**
- 6. Labeling**
- 7. Packing**
- 8. Recommended solder pad**
- 9. Soldering**
- 10. Precaution for use**
- 11. Handling of Silicone Resin LEDs**

## 1. Full code of Z5 series

Full code form :  $X_1 X_2 X_3 X_4 X_5 X_6 X_7 X_8$

### 1. Part Number

$X_1$	Company
-------	---------

$X_2$	Z-Power LED series number
-------	---------------------------

$X_3 X_4$	Color Specification
G0	Green

$X_5$	PKG Series
5	Z5 series

$X_6$	Lens type
-------	-----------

$X_7$	PCB Type
-------	----------

### 2. Internal Number

$X_8$	Revision No.
-------	--------------

## 2. Outline dimensions

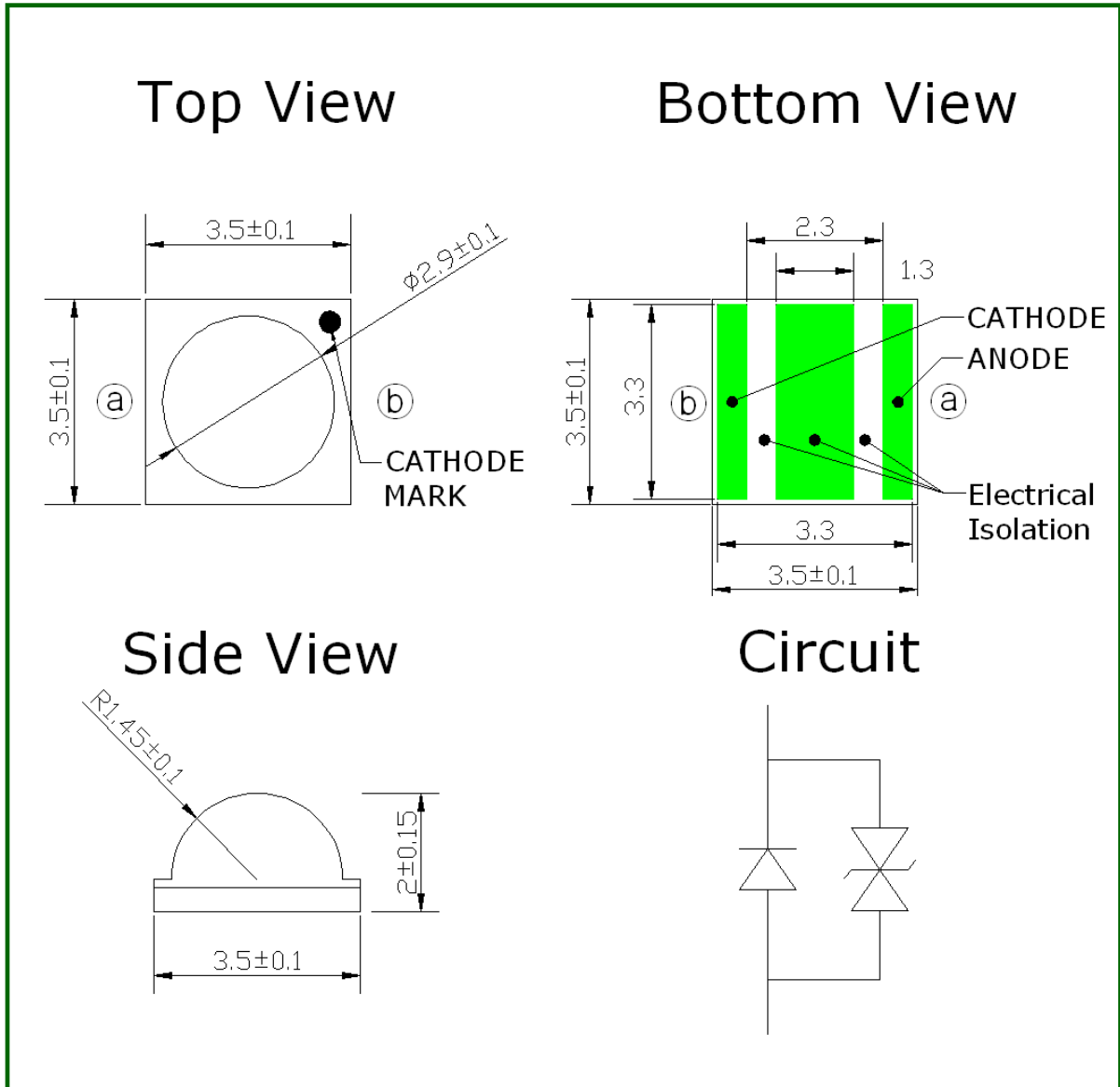

Notes :

- [1] All dimensions are in millimeters.
- [2] Scale : none
- [3] Undefined tolerance is  $\pm 0.1$ mm

### 3. Characteristics of SZG05A0A (Green)

#### Green

##### 1-1 Electro-Optical characteristics at 350mA

(Ta=25°C, RH30%)

Parameter	Symbol	Value			Unit
		Min	Typ	Max	
Luminous Flux [1]	$\Phi_V$ [2]	70	100	118.5	lm
	$\Phi_V$ (Tj=100°C)	-	87	-	
Dominant Wavelength[3]	$\lambda_D$	518	525	530	nm
Forward Voltage [4]	$V_F$	3.0	3.3	4.0	V
Thermal resistance (J to S)	$R_{\theta_{J-S}}$	10.0			K /W
View Angle	$2\theta \frac{1}{2}$	128			deg.

##### 1-2 Absolute Maximum Ratings

Parameter	Symbol	Value	Unit
Forward Current	$I_F$	700	mA
Reverse Voltage	$V_r$	5	V
Power Dissipation	$P_d$	3	W
Junction Temperature	$T_j$	145(@ $I_F \leq 700mA$ )	°C
Operating Temperature	$T_{opr}$	-40 ~ +100	°C
Storage Temperature	$T_{stg}$	-40 ~ +100	°C
ESD Sensitivity(HBM) [6]	-	2	kV

\*Notes :

[1] SSC maintains a tolerance of  $\pm 7\%$  on flux and power measurements.

[2]  $\Phi_V$  is the total luminous flux output as measured with an integrating sphere.

[3] Correlated Color Temperature is derived from the CIE 1931 Chromaticity diagram.

Color coordinate :  $\pm 0.005$ , CCT  $\pm 5\%$  tolerance.

[4] Tolerance is  $\pm 0.06V$  on forward voltage measurements

[5] A zener diode is included to protect the product from ESD.

[6] Tolerance is  $\pm 2.0$  on CRI measurements

## 4. Characteristic diagrams

### Color Spectrum

(IF=350mA, Ta=25℃, RH30%)

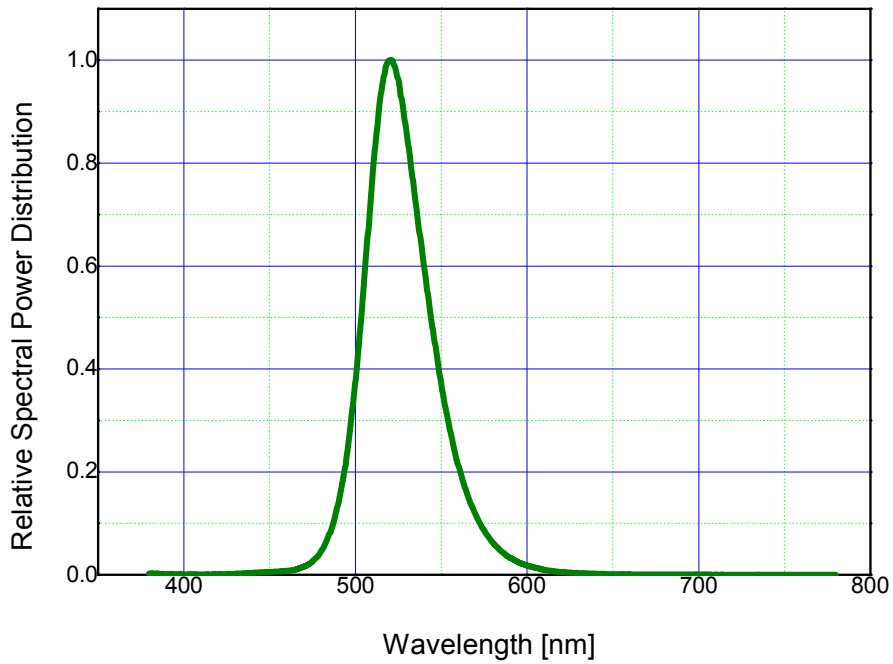

## Forward Current Characteristics

**Forward Voltage vs. Forward Current, Ta=25℃**

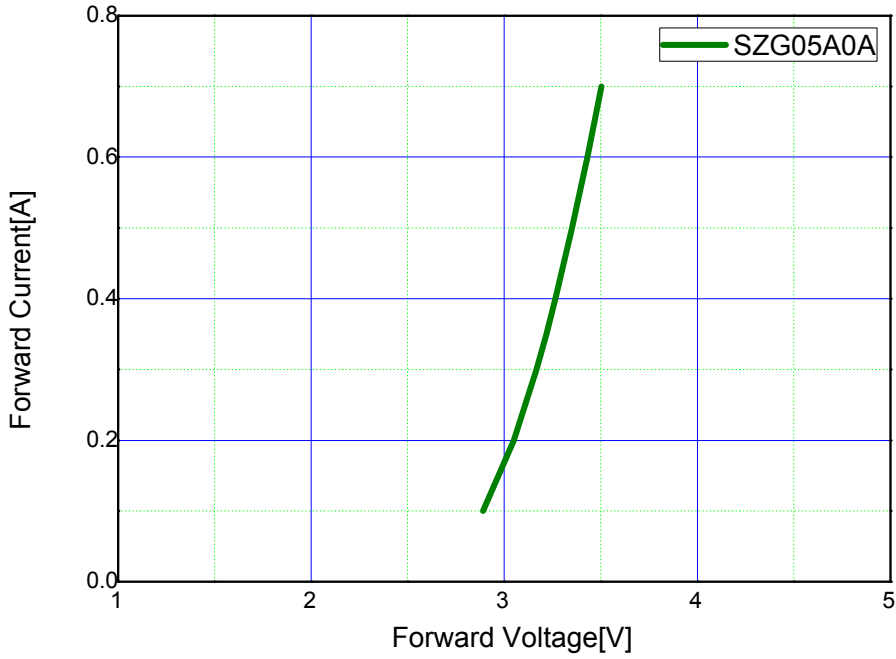

**Forward Current vs. Normalized Relative Luminous Flux, Ta=25℃**

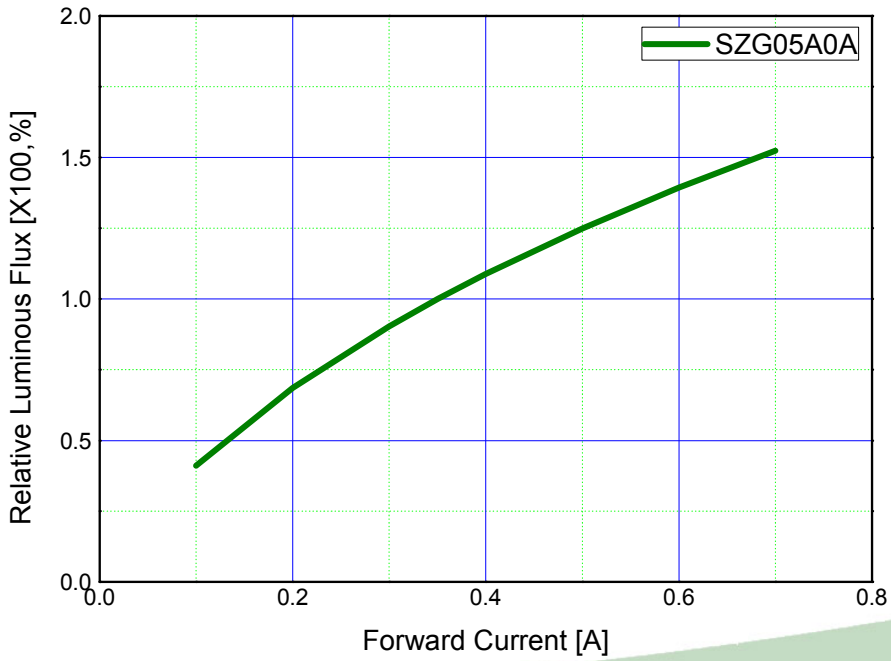



**Forward Current vs Wavelength Shift, Ta=25℃**

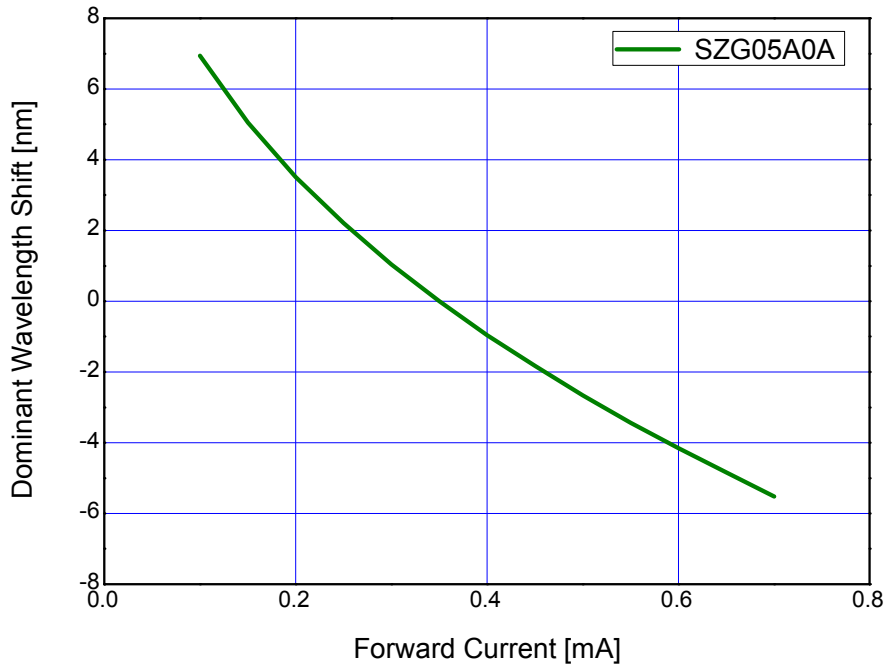

## Junction Temperature Characteristics

**Junction Temperature vs. Relative Light Output at IF=350mA**

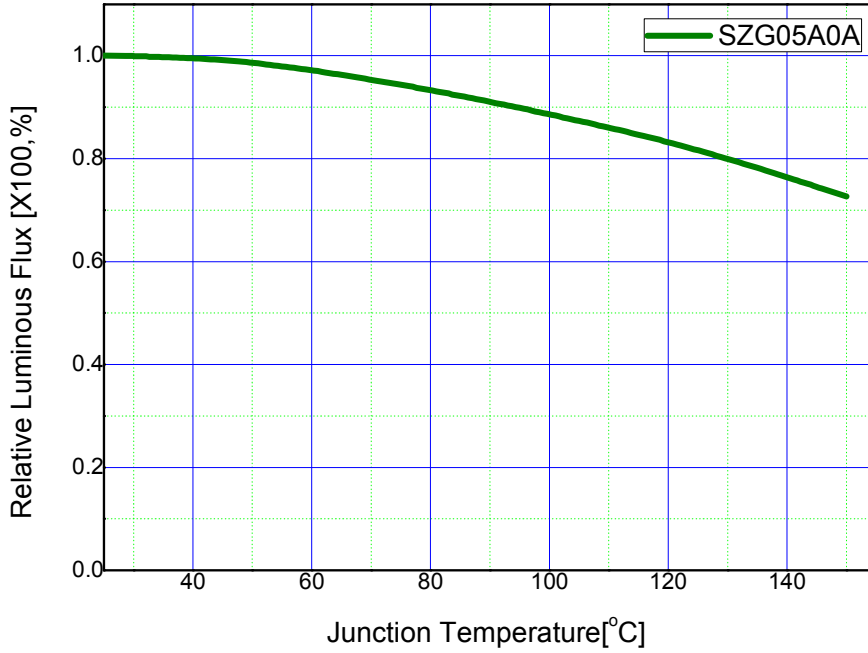

**Junction Temperature vs. Forward Voltage at IF=350mA**

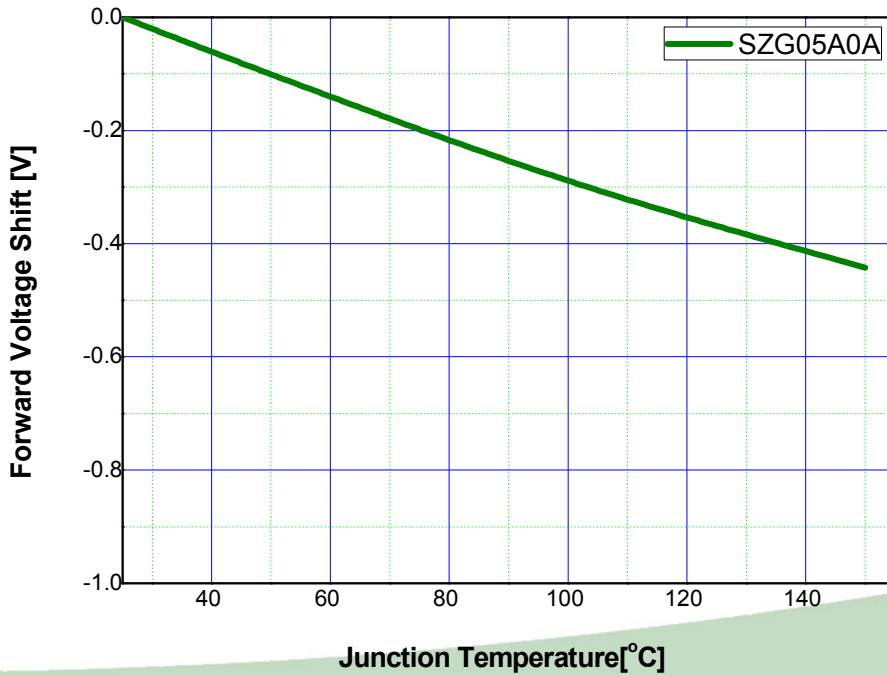

## Junction Temperature Characteristics

### Junction Temperature vs. Dominant Wavelength at IF=350mA

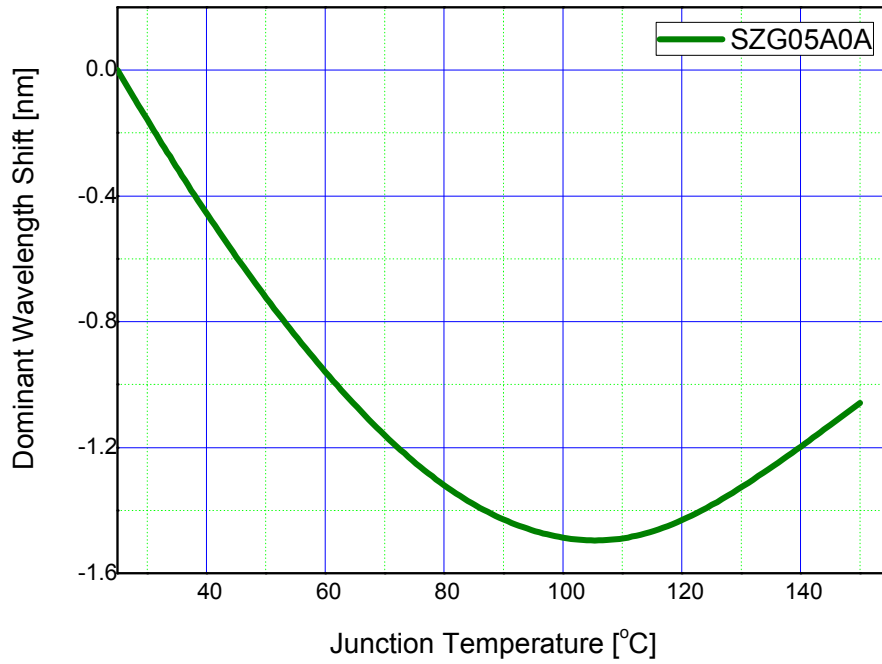

**Characteristic diagrams**

**Ambient Temperature vs. Allowable Forward Current (Tjmax = 145°C, @0.7A)**

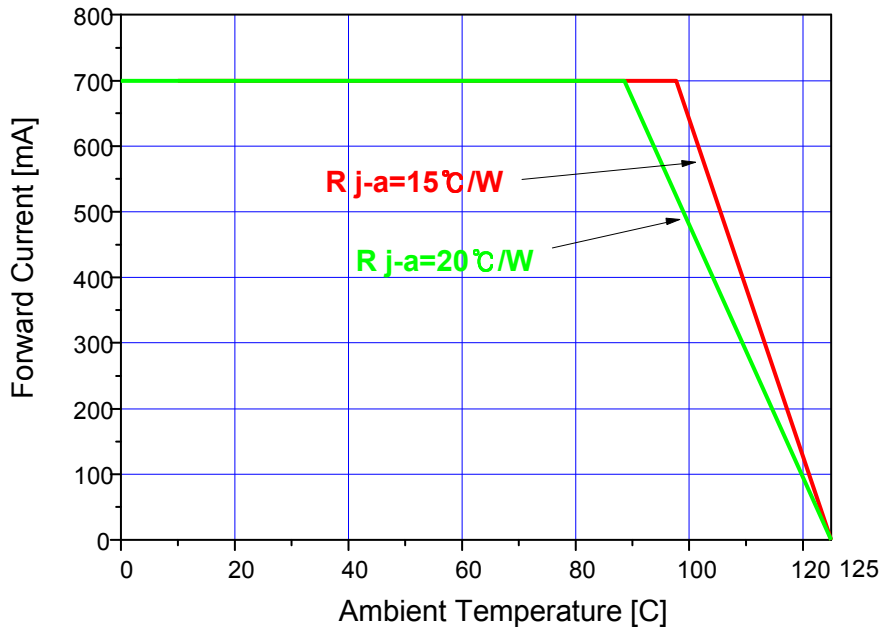

**Radiation pattern at 350mA**

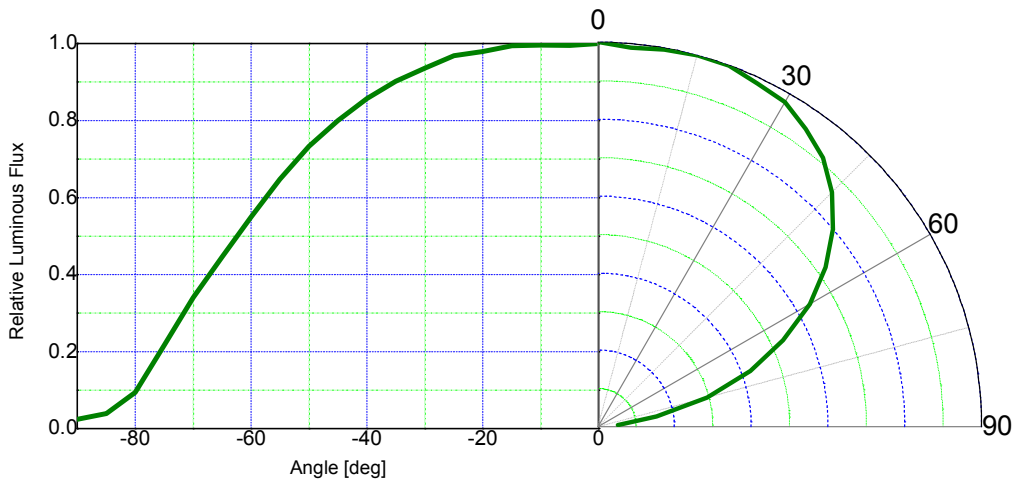

## 5. Bin Code Description

Bin Code		
Radiant Power (mW) @ $I_F = 350\text{mA}$	Dominant Wavelength (nm) @ $I_F = 350\text{mA}$	Forward Voltage (V) @ $I_F = 350\text{mA}$
T2	GG1	H

↓

Radiant Power (mW) @ $I_F = 350\text{mA}$		
Bin Code	Min.	Max.
S	54.0	70.0
T1	70.0	80.0
T2	80.0	90.0
U1	91.0	100.0
U2	100.0	109.0
U3	109.0	118.5





↓

Dominant Wavelength (nm) @ $I_F = 350\text{mA}$		
Bin Code	Min.	Max.
GG1	518	525
GG2	525	530

↓

Forward Voltage (V) @ $I_F = 350\text{mA}$		
Bin Code	Min.	Max.
H	3.00	3.25
I	3.25	3.50
J	3.50	3.75

## 6. Labeling

Rank :	 X <sub>10</sub> X <sub>11</sub> X <sub>12</sub> X <sub>13</sub>
Quantity : 1000	
Lot No : #####	
SSC PART NUMBER : SZG05A0A	
 SZG05A0A	

### Full code form

X<sub>1</sub>X<sub>2</sub>X<sub>3</sub>X<sub>4</sub>X<sub>5</sub>X<sub>6</sub>X<sub>7</sub>X<sub>8</sub>

- X<sub>1</sub> : Company
- X<sub>2</sub> : Z-Power LED series number
- X<sub>3</sub> X<sub>4</sub> : Color Specification
- X<sub>5</sub> : PKG Series
- X<sub>6</sub> : Lens Type
- X<sub>7</sub> : PCB Type
- X<sub>8</sub> : Revision No.

### Rank

X<sub>10</sub>X<sub>11</sub>X<sub>12</sub>X<sub>13</sub>

- X<sub>10</sub> : Luminous Flux : LF [lm]
- X<sub>11</sub>X<sub>12</sub> : Dominant Wavelength [nm]
- X<sub>13</sub> : Forward Voltage : V<sub>F</sub> [V]

### Lot No

#1#2#3#4#5#6 - #7#8#9#10 - #11#12#13

- |   |   |
|---|---|
| - # <sub>1</sub> # <sub>2</sub> : Year  | - # <sub>7</sub> # <sub>8</sub> # <sub>9</sub> # <sub>10</sub> : Mass order |
| - # <sub>3</sub> # <sub>4</sub> : Month | - # <sub>11</sub> # <sub>12</sub> # <sub>13</sub> : Tray No.                |
| - # <sub>5</sub> # <sub>6</sub> : Day   |   |

## 7. Packing

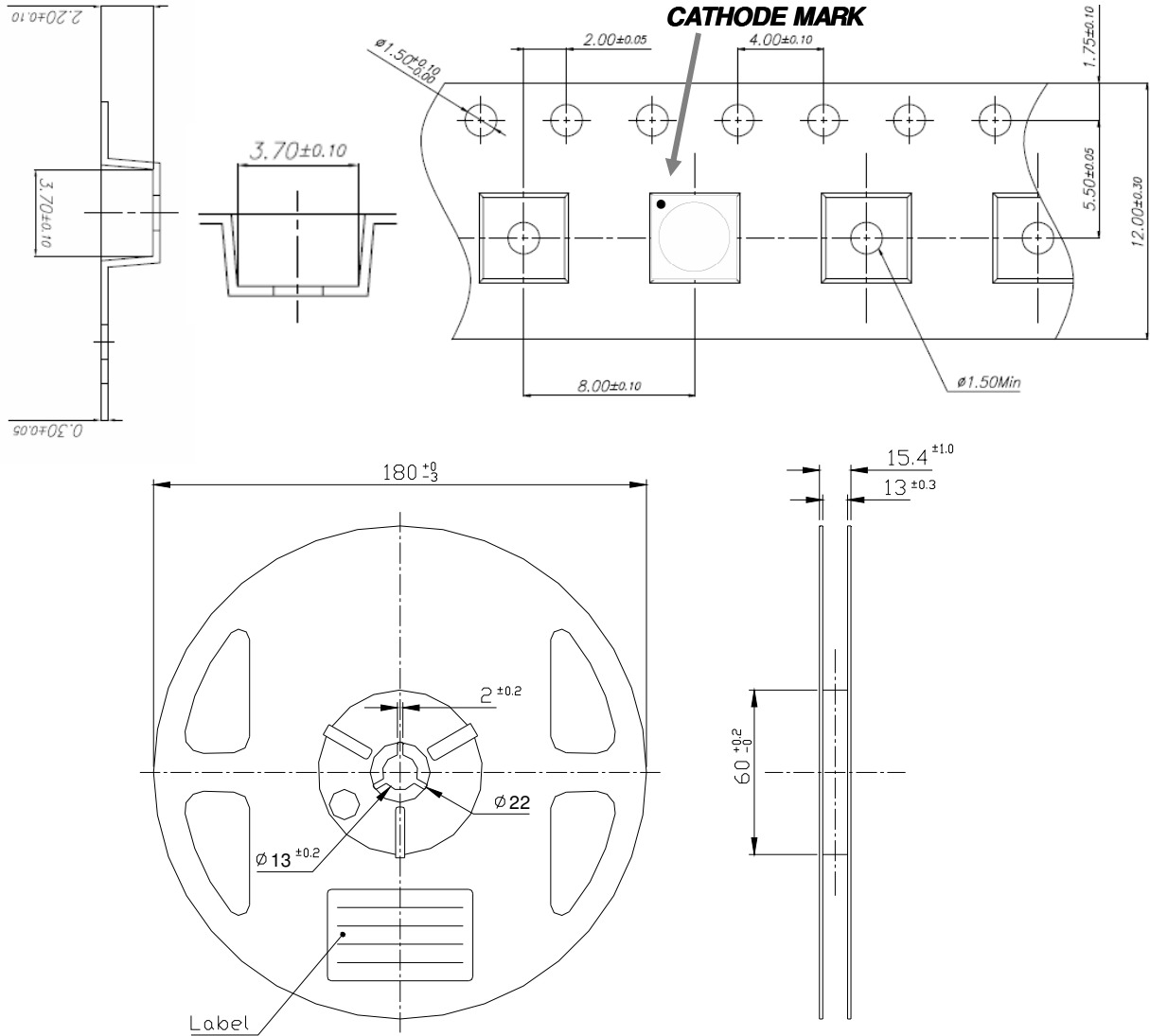

**NOTES:**

1. 10 sprocket hole pitch cumulative tolerance  $\pm 0.20$
2. Camber not to exceed 1mm in 250mm
3. Material: Black conductive Polystyrene
4.  $A_0$  and  $B_0$  measured on a plane 0.3mm above the bottom of the pocket
5.  $K_0$  measured from a plane on the inside bottom of the pocket to the top surface of the carrier.
6. Pocket position relative to sprocket hole measured as true position of pocket, not pocket hole.
7. Pocket center and pocket hole center must be same position.

## 7. Packing

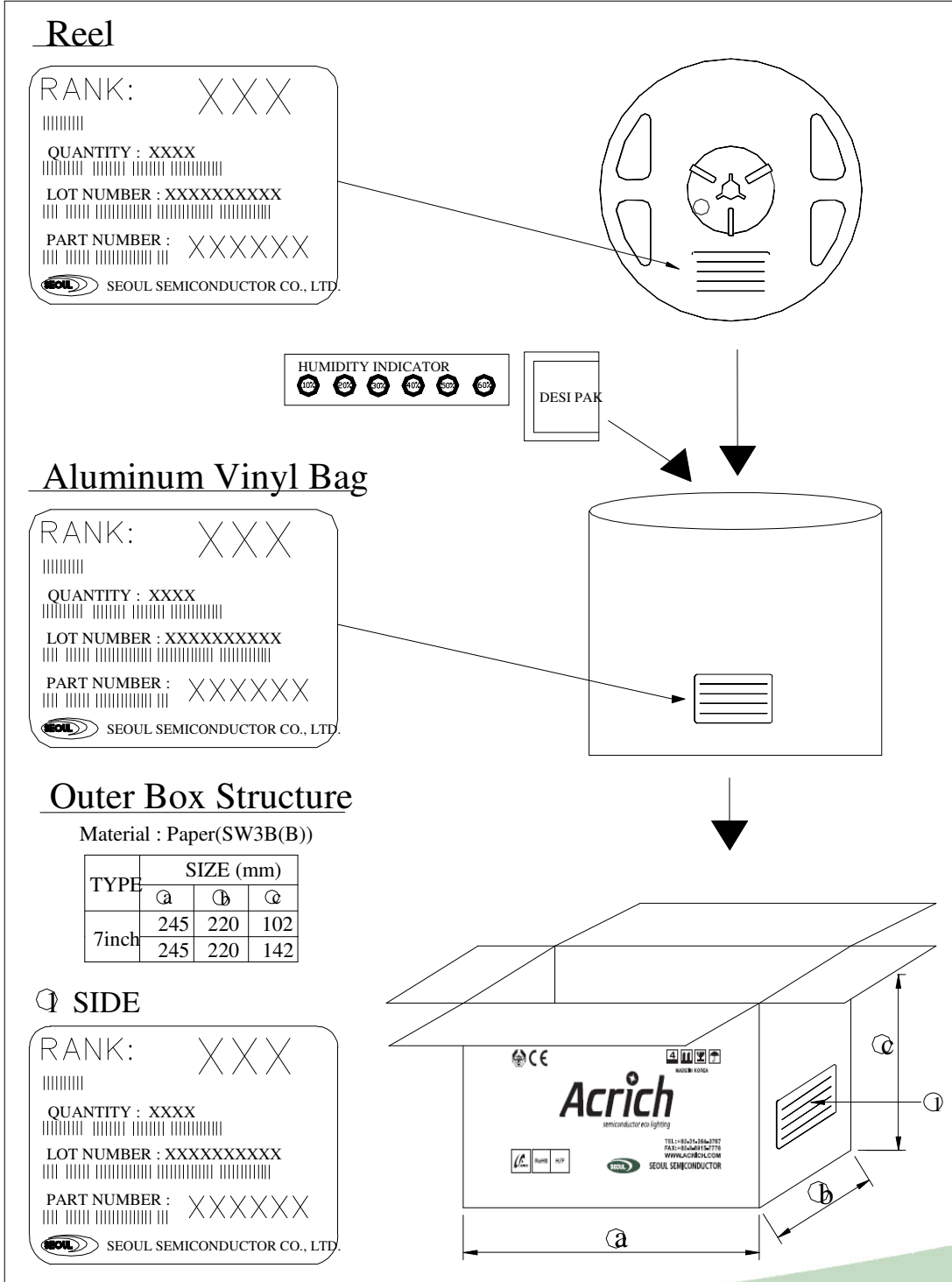



## 8. Recommended solder pad

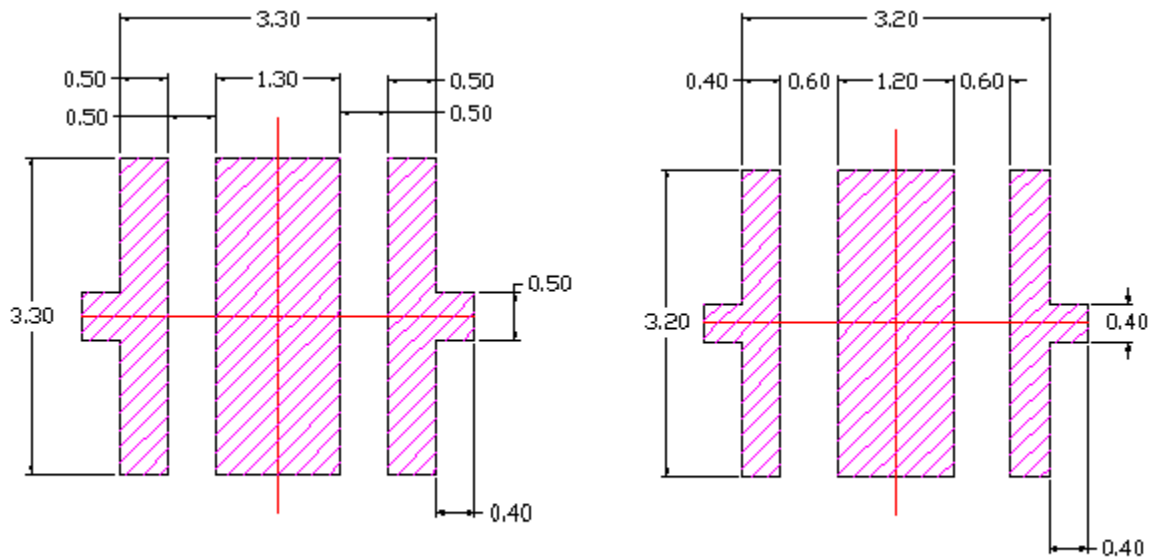

Recommended PCB Solder Pad

Recommended Stencil Pattern

Notes :

- [1] All dimensions are in millimeters.
- [2] Scale : none
- [3] This drawing without tolerances are for reference only
- [4] Undefined tolerance is  $\pm 0.1\text{mm}$

## 9. Soldering

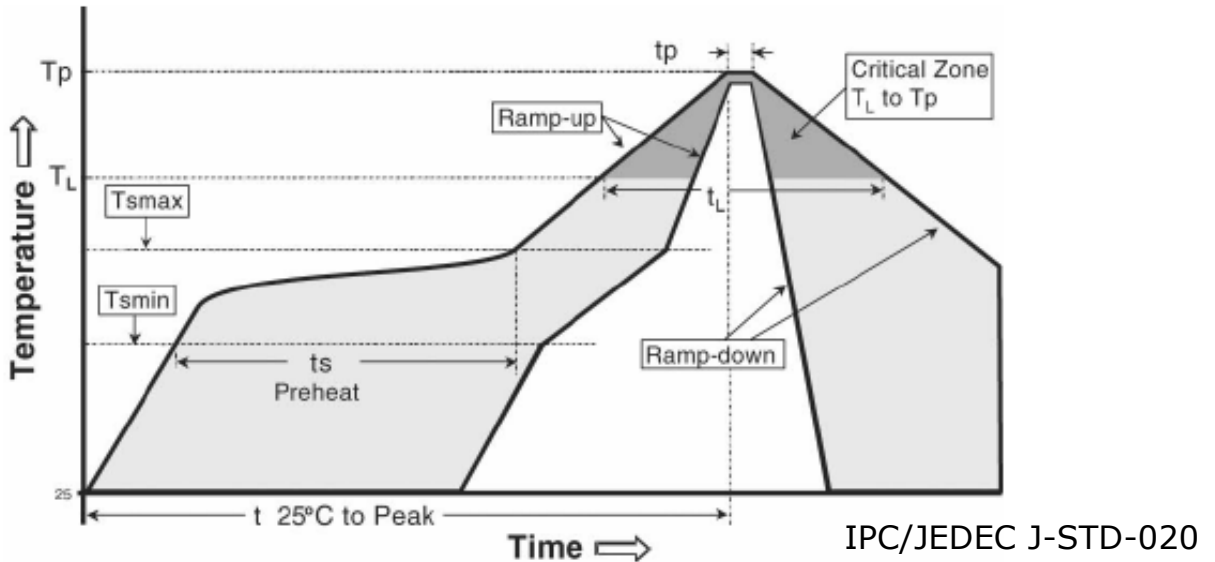

Profile Feature	Sn-Pb Eutectic Assembly	Pb-Free Assembly
<b>Average ramp-up rate (T Amin to Tp)</b>	3° C/second max.	3° C/second max.
<b>Preheat</b> - Temperature Min (T Amin) - Temperature Max (T smax) - Time (T Amin to T smax) (ts)	100 °C 150 °C 60-120 seconds	150 °C 200 °C 60-180 seconds
Time maintained above: - Temperature (TL) - Time (tL)	183 °C 60-150 seconds	217 °C 60-150 seconds
Peak Temperature (Tp)	215 °C	260 °C
Time within 5°C of actual Peak Temperature (tp)2	10-30 seconds	20-40 seconds
Ramp-down Rate	6 °C/second max.	6 °C/second max.
Time 25°C to Peak Temperature	6 minutes max.	8 minutes max.

**\* Caution**

1. Reflow soldering is recommended not to be done more than two times. In the case of more than 24 hours passed soldering after first, LEDs will be damaged.
2. Repairs should not be done after the LEDs have been soldered. When repair is unavoidable, suitable tools must be used.
3. Die slug is to be soldered.
4. When soldering, do not put stress on the LEDs during heating.
5. After soldering, do not warp the circuit board.

## 10. Precaution for use

(1) Storage

To avoid the moisture penetration, we recommend storing Z5 Series (Z Power) LEDs in a dry box with a desiccant . The recommended storage temperature range is 5℃ to 30℃ and a maximum humidity of RH50%.

(2) Use Precaution after Opening the Packaging

Use proper SMD techniques when the LED is to be soldered dipped as separation of the lens may affect the light output efficiency. Pay attention to the following:

a. Recommend conditions after opening the package

- Sealing
- Temperature : 5 ~ 40℃ Humidity : less than RH30%

b. If the package has been opened more than 1 year (MSL 2) or the color of the desiccant changes, components should be dried for 10-12hr at 60±5℃

(3) Do not apply mechanical force or excess vibration during the cooling process to normal temperature after soldering.

(4) Do not rapidly cool device after soldering.

(5) Components should not be mounted on warped (non coplanar) portion of PCB.

(6) Radioactive exposure is not considered for the products listed here in.

(7) Gallium arsenide is used in some of the products listed in this publication. These products are dangerous if they are burned or shredded in the process of disposal. It is also dangerous to drink the liquid or inhale the gas generated by such products when chemically disposed of.

(8) This device should not be used in any type of fluid such as water, oil, organic solvent and etc. When washing is required, IPA (Isopropyl Alcohol) should be used.

(9) When the LEDs are in operation the maximum current should be decided after measuring the package temperature.

(10) LEDs must be stored properly to maintain the device. If the LEDs are stored for 3 months or more after being shipped from SSC, a sealed container with a nitrogen atmosphere should be used for storage.

(11) The appearance and specifications of the product may be modified for improvement without notice.

(12) Long time exposure of sunlight or occasional UV exposure will cause lens discoloration.

## 10. Precaution for use

- (13) VOCs (Volatile organic compounds) emitted from materials used in the construction of fixtures can penetrate silicone encapsulants of LEDs and discolor when exposed to heat and photonic energy. The result can be a significant loss of light output from the fixture. Knowledge of the properties of the materials selected to be used in the construction of fixtures can help prevent these issues.
- (14) The slug is isolated from anode electrically.  
Therefore, we recommend that you don't isolate the heat sink.
- (15) Attaching LEDs, do not use adhesives that outgas organic vapor.
- (16) The driving circuit must be designed to allow forward voltage only when it is ON or OFF.  
If the reverse voltage is applied to LED, migration can be generated resulting in LED damage.

## 11. Handling of Silicone Resin LEDs

- (1) During processing, mechanical stress on the surface should be minimized as much as possible. Sharp objects of all types should not be used to pierce the sealing compound.

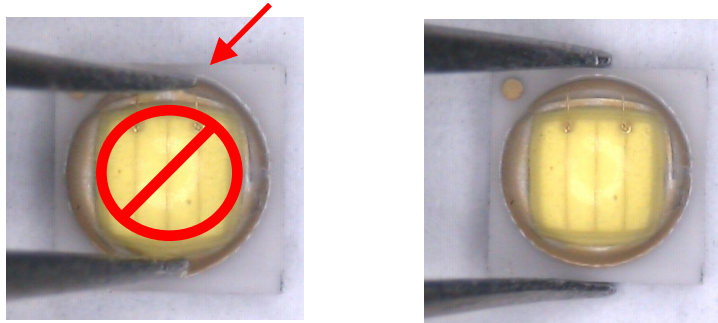

- (2) In general, LEDs should only be handled from the side. By the way, this also applies to LEDs without a silicone sealant, since the surface can also become scratched.
- (3) When populating boards in SMT production, there are basically no restrictions regarding the form of the pick and place nozzle, except that mechanical pressure on the surface of the resin must be prevented. This is assured by choosing a pick and place nozzle which is larger than the LED's reflector area.
- (4) Silicone differs from materials conventionally used for the manufacturing of LEDs. These conditions must be considered during the handling of such devices. Compared to standard encapsulants, silicone is generally softer, and the surface is more likely to attract dust. As mentioned previously, the increased sensitivity to dust requires special care during processing. In cases where a minimal level of dirt and dust particles cannot be guaranteed, a suitable cleaning solution must be applied to the surface after the soldering of components.
- (5) SSC suggests using isopropyl alcohol for cleaning. In case other solvents are used, it must be assured that these solvents do not dissolve the package or resin. Ultrasonic cleaning is not recommended. Ultrasonic cleaning may cause damage to the LED.
- (6) Please do not mold this product into another resin (epoxy, urethane, etc) and do not handle this product with acid or sulfur material in sealed space.
- (7) Avoid leaving fingerprints on silicone resin parts.